

Meta Physics

# Unlimited Human Potential!



## Nepal Engineers' Association Talk Program



Who are we & Why we are here?

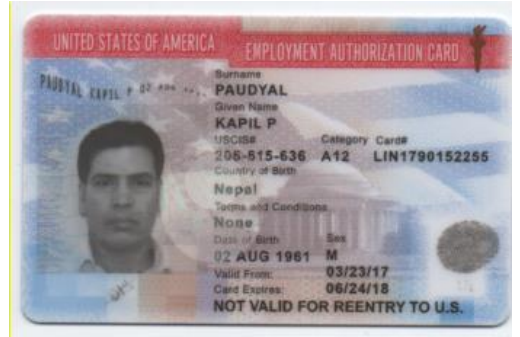
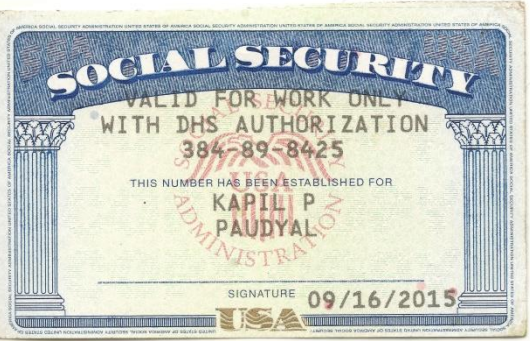
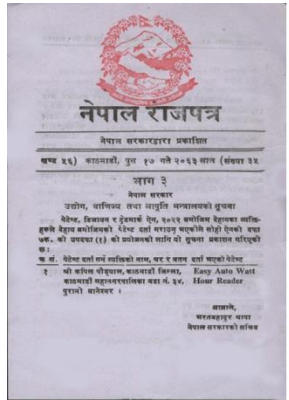
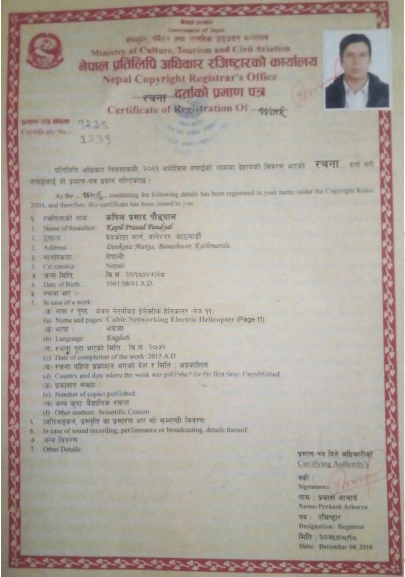
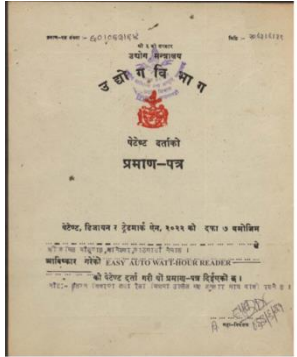
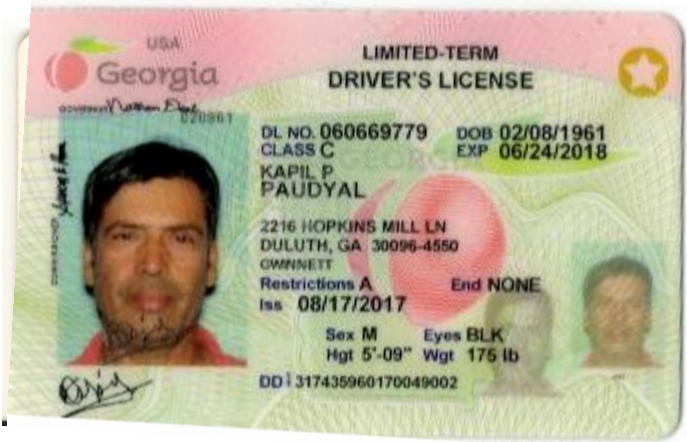

**Er. Kapil Paudyal**  
**Patent Honor Scientist**









# Patent **EAWHR** (SMART Meter)

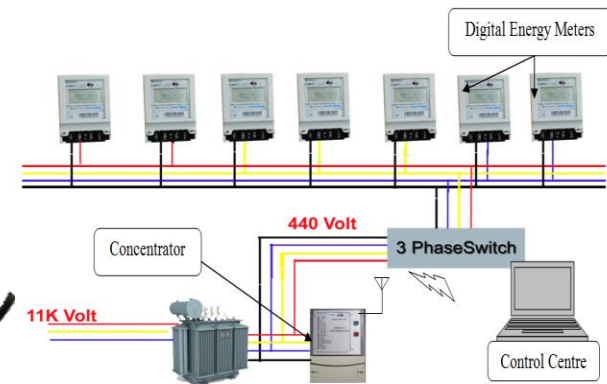
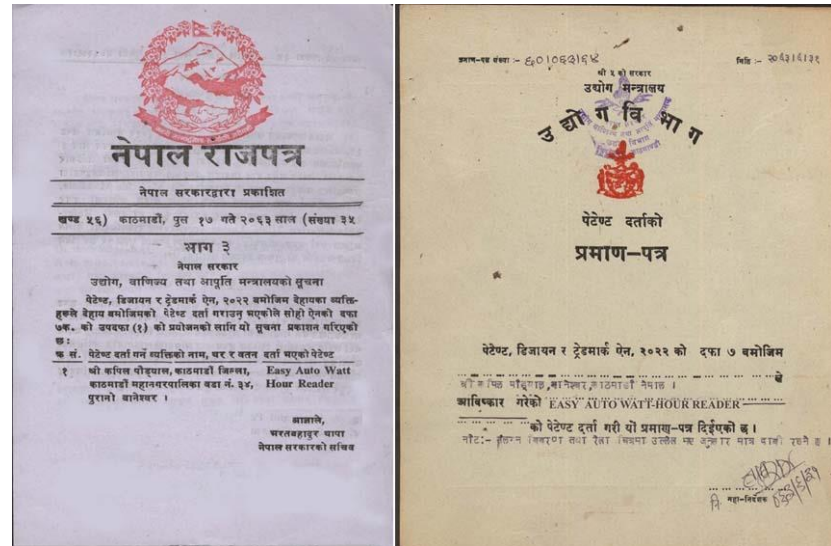
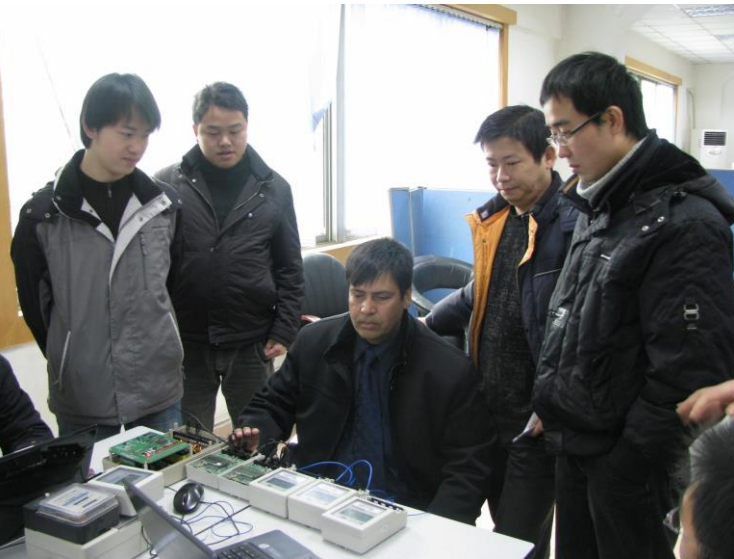

Figure 1: Detail Model of smart grid with EAWHR



**AVOID LOAD SHEDDING**



# Successes the Pilot project of EAWHR

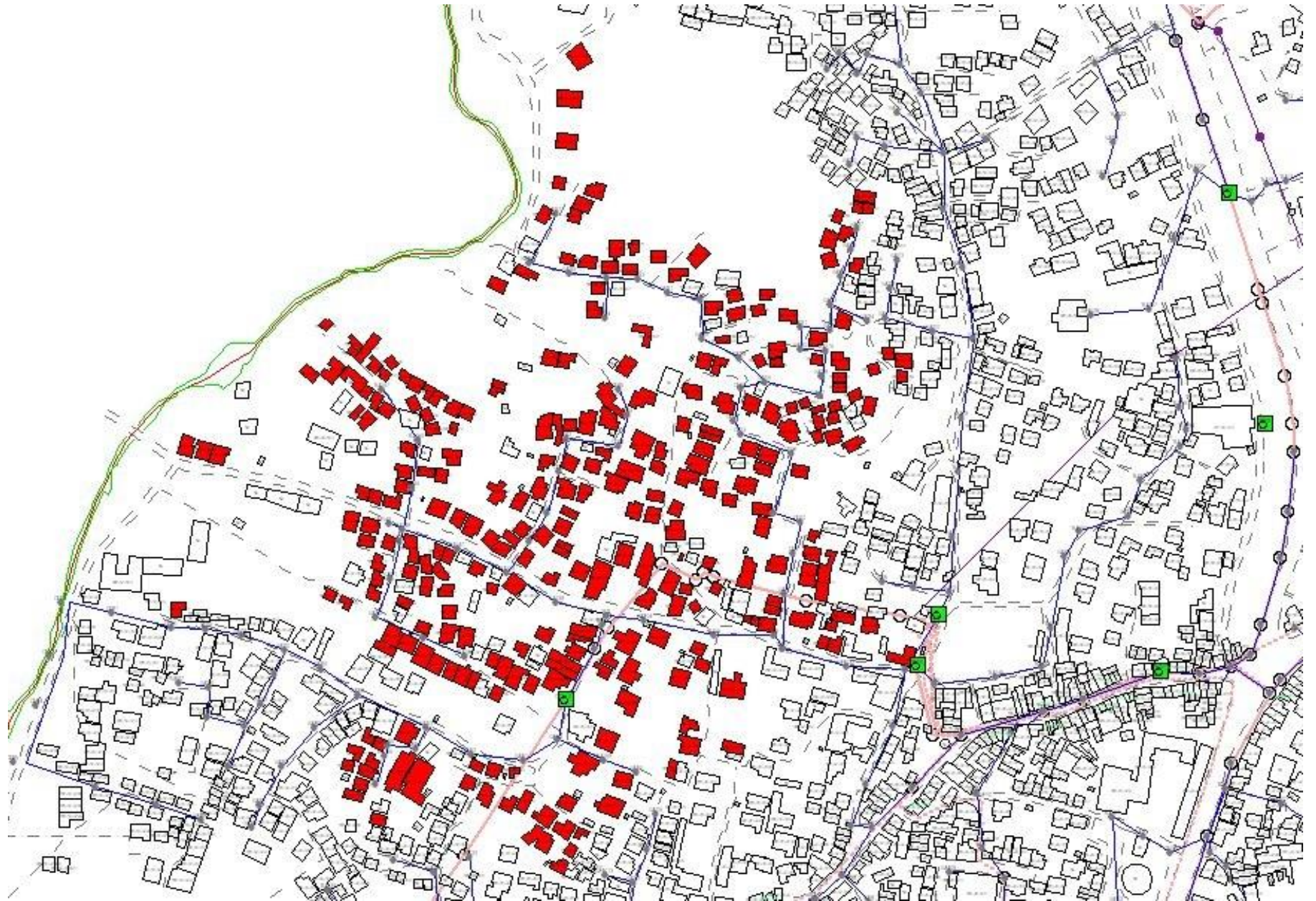



# Installation EAWHR





# EAWHR News

Nepal TV News  
Kantipur Aaj News  
Nepal Patrika News  
News 24 News  
National TV  
Hamrakura e-news

If you type EAWHR in any Browser,  
You may get the News about Invention.



# Desert Land into Fertile Land Conversion

## 3<sup>rd</sup> Invention

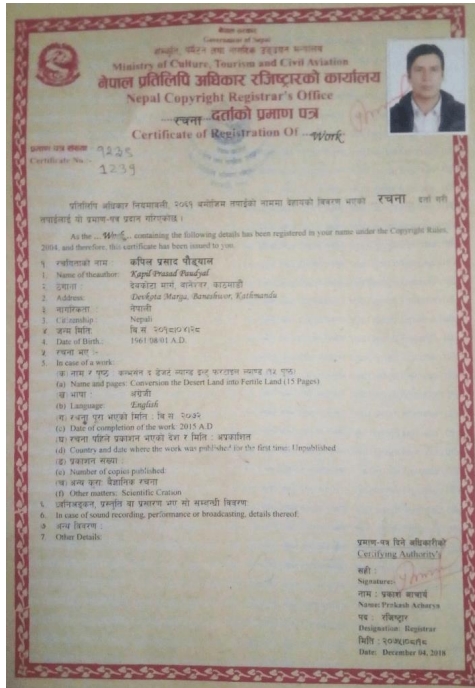



# Transportation for Complex Mountain 3<sup>rd</sup> Invention



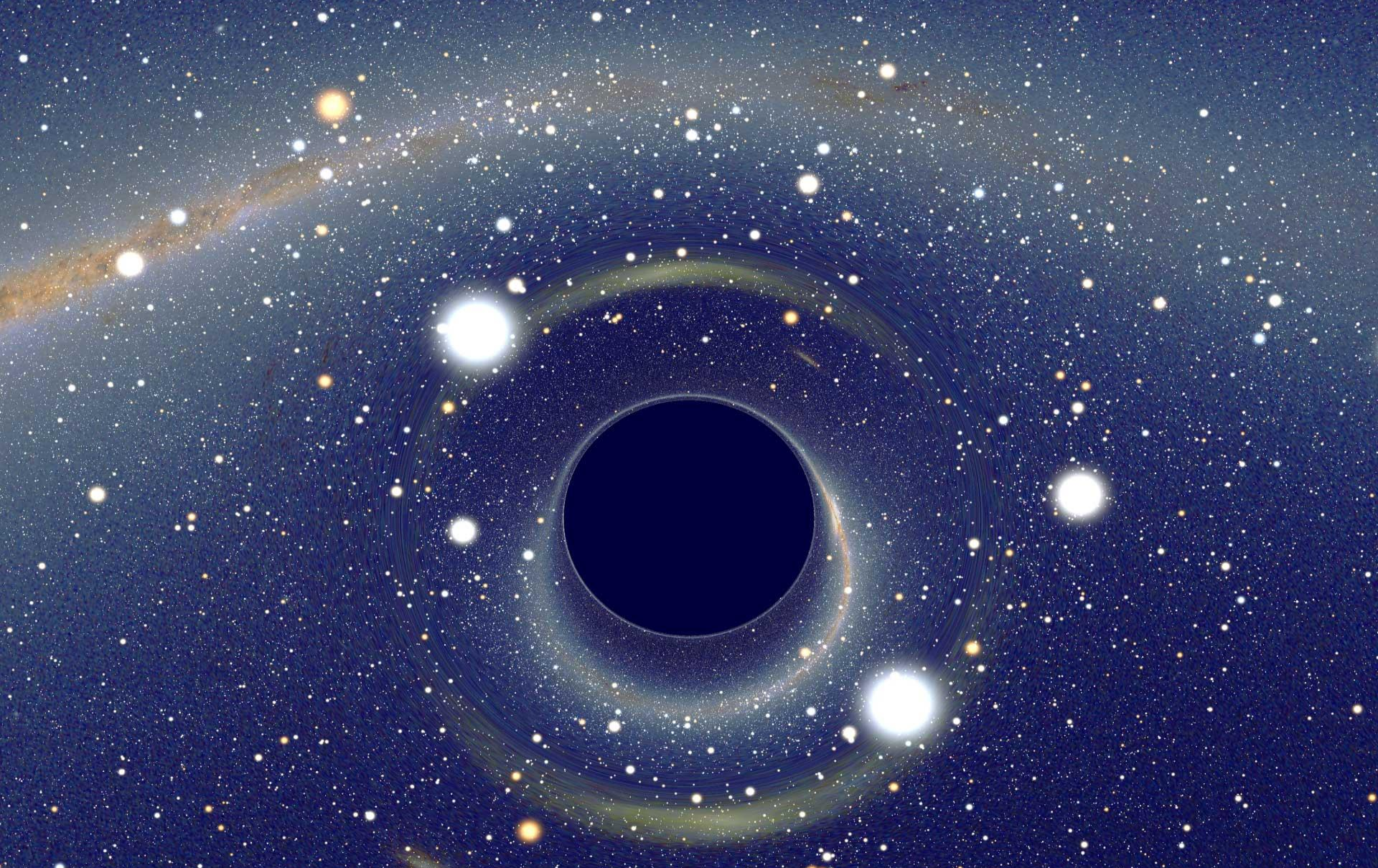

**Everything is Possible**

# Who am I?

Hidden Intelligence & Intuition

More than 1000 Gurus



# HIGGS BOSON

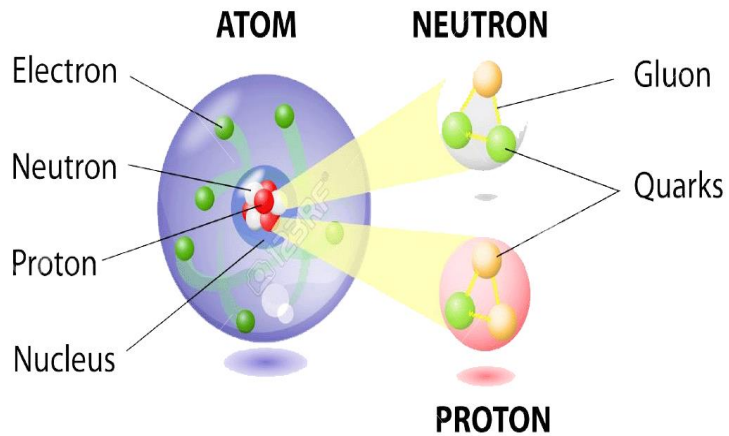

# अदृश्य परिचालक

## Hidden Intelligence

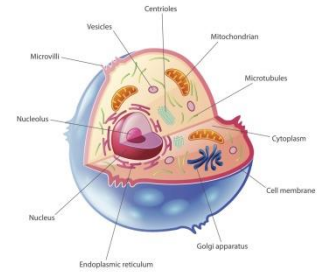

### HUMAN CIRCULATORY SYSTEM DENoyer-GEPPERT

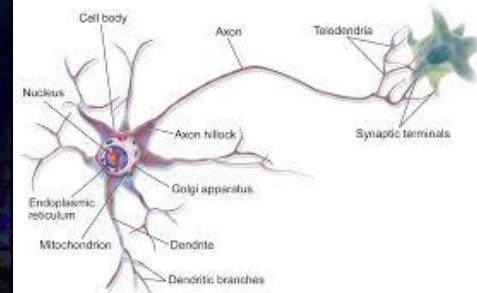
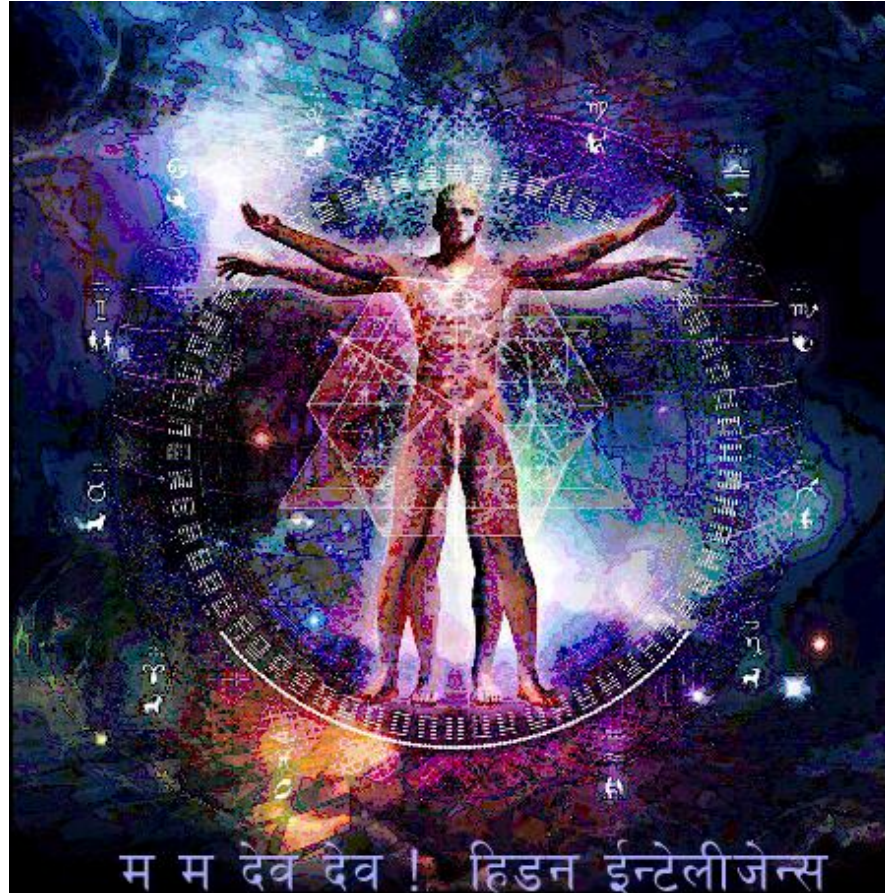
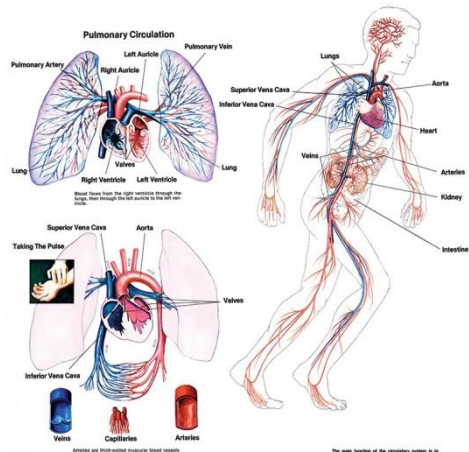

म म देव देव ! हिडन इन्टेलीजेन्स

Every problem has a solution





A glowing, wireframe brain is shown floating in a blue sky. The brain is composed of white, interconnected lines, giving it a digital or neural appearance. In the lower right foreground, the silhouettes of a person and a child are visible, looking towards the brain. The background features a sunset or sunrise over a body of water, with a bright sun low on the horizon. The overall scene is set against a deep blue sky with some light clouds.

Cloud

Unlimited Human Potential



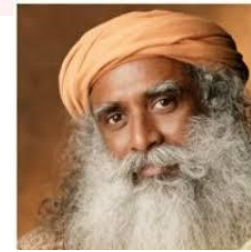
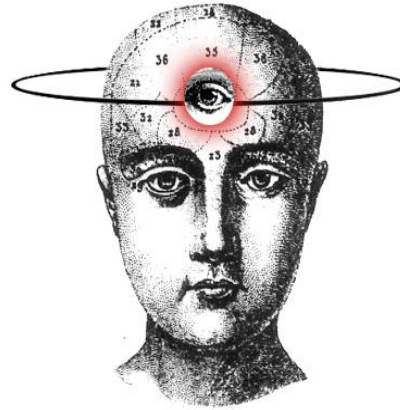
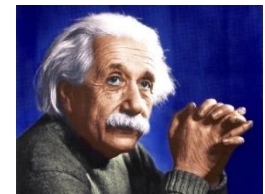
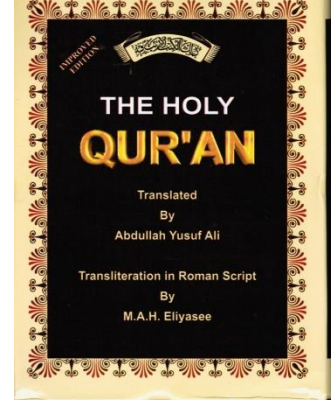
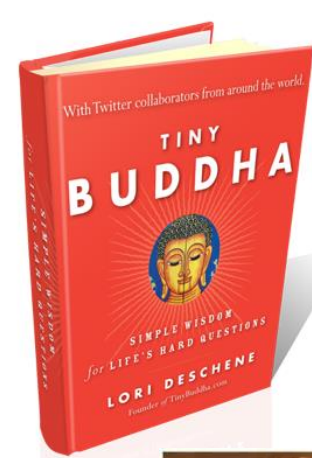
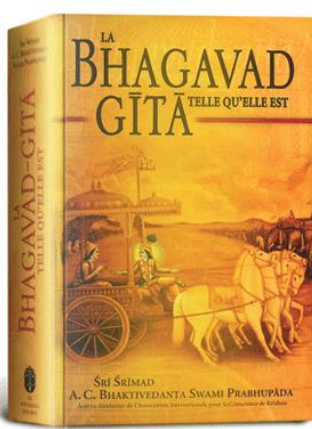
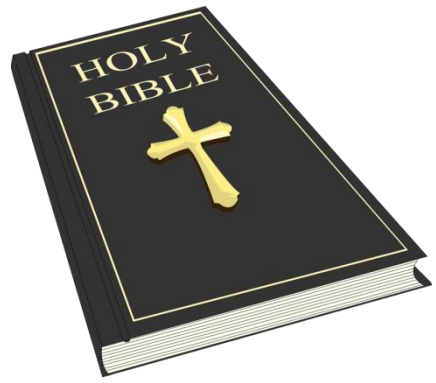

You are lucky or fortunate !

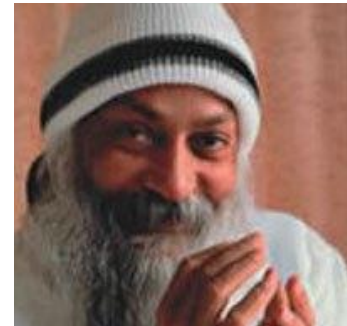
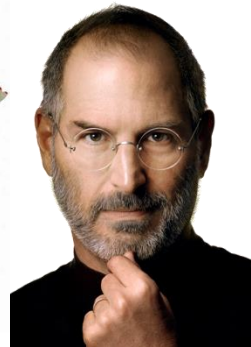



# ज्ञानको सागर

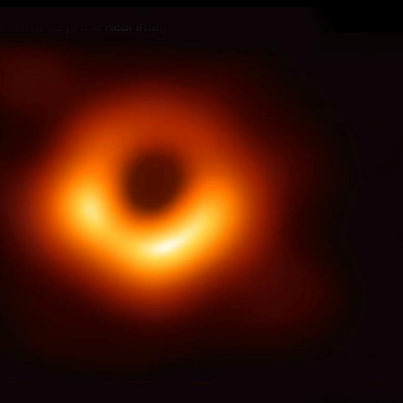
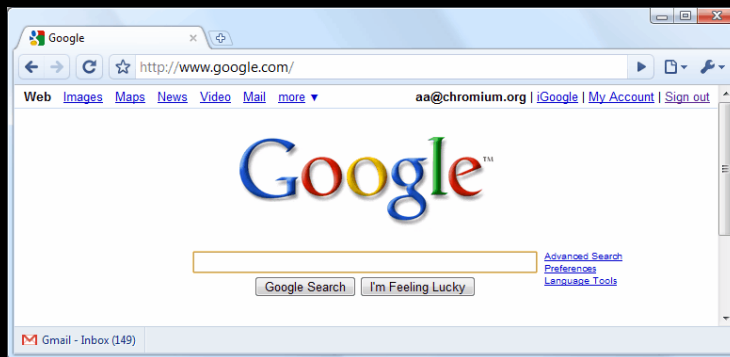

# Natural Resources!



# Mega-copter/Robo-copter





रुबी



माउन्ट एभरेष्ट



ग्यास

नुन

युरानियम

ल्पाटिनियम

पेट्रोल



सुन



तातोपानी कुण्ड



कोईला

यासागुम्बा

तामा



# Government of Nepal









# Every problem has a solution !

## PROBLEM

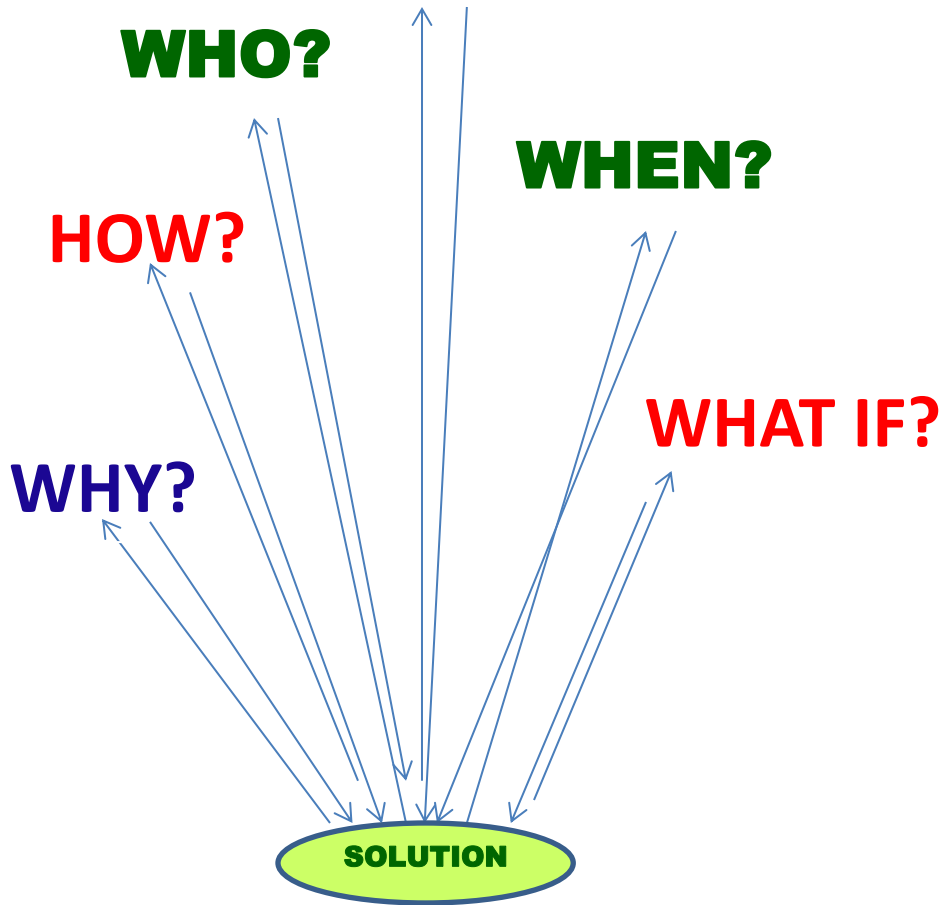

# Vision + Money

नेता

SMARTI  
Management

Engineers

Doctor

Lawyer

पत्रकार



Link



# Update



16 Phone



अवचेतल मनको योजना

## Sub-Conscious Mind Program

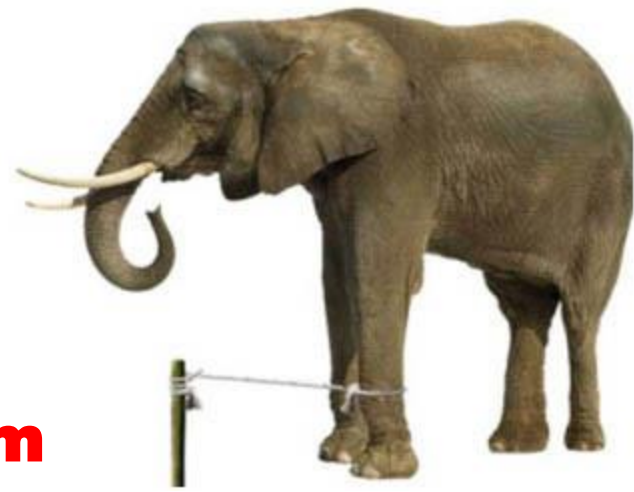

Earth is round



Galileo



Mount Everest

# Innovation

## The Theory of Glorious Revolution





# Secret of Success



The Glorious Movement for Peaceful World  
**International Institute of Infitinism**

Hidden Intell **USA** & Intuition

**SMART Intelligence + Money**



# The Theory of Glorious Revolution

## Hidden Intelligence Group

Knocking to 7 Billion Heart



More Than 100 countries are crying All over the Globe.

# Difference between man & Animal

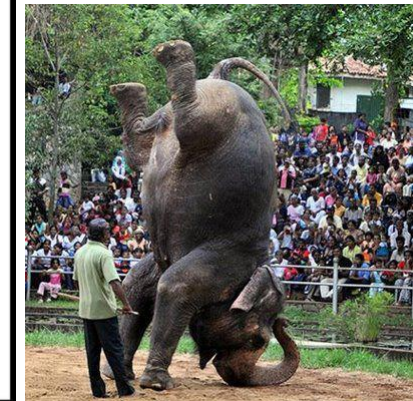

# What We Want....



**Planning**

**LAW?**

**Education?**

**Ruling?**

**Work?**

**Income?**

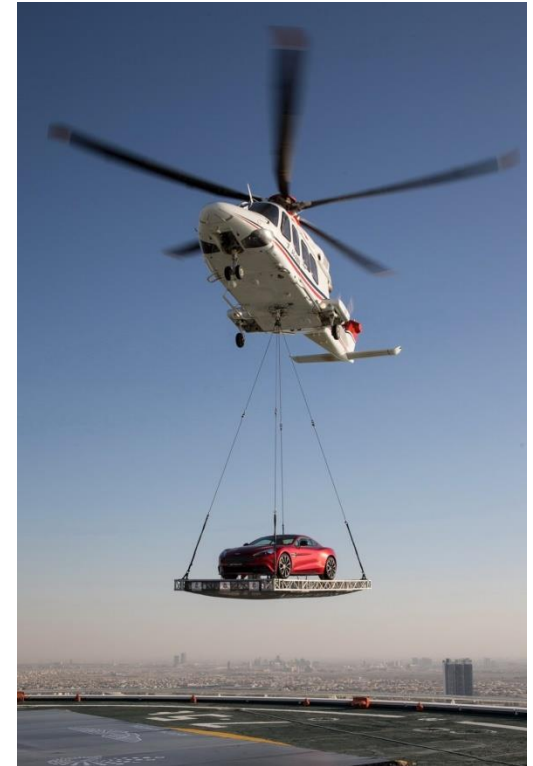



# हामी यस्तो देशमा बसि रहेका छौ ।

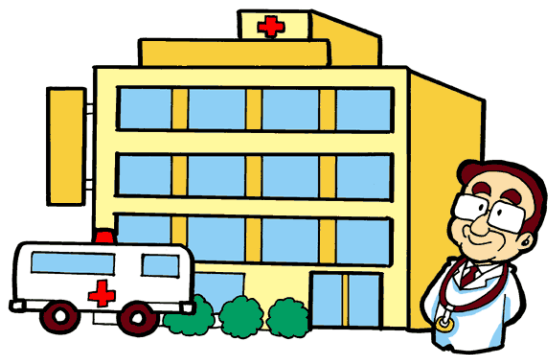

**hospital**



**Let's see what it is!**



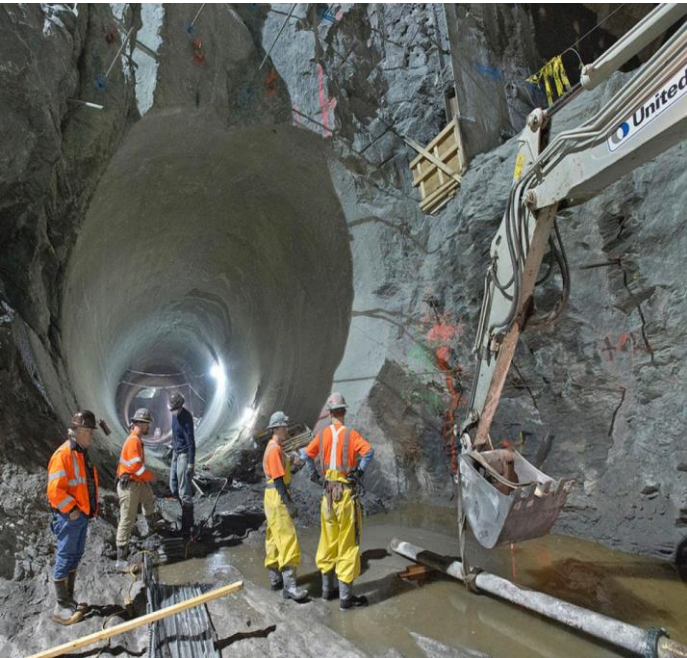

**NEPAL is a richest country of the World !**





# Planning and Mega Constructions



# Human Capacity

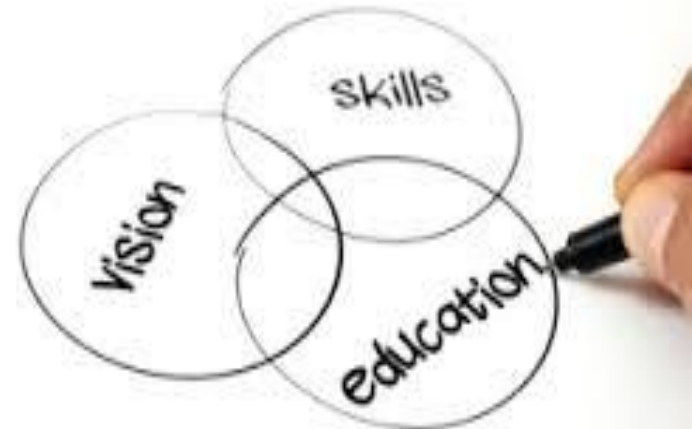

# **55 KM Bridge in the Sea**





港珠澳大桥欢迎您!

80

80

50

江湾路  
全长 994  
米

# Remote Tunnel Maker



# गोप्य ज्ञान

**Cow..... Farming**

**Pre Fab manufacturing**

**Fruits Garden Fun park**

**Waist Recycling**



**Science Park**

**IT**

**Mosquito Paint**

**Wine Farm**

**Fun Park**

**Farmers market**

**Water kingdom**

**Butterfly Pavilion**

**Natural Resources**

**PLAZA**

**Love/English park**

**SMART ड़ोन**

**Fly wheel Free Energy**

**Housing**

**Toll Road**

**Land Plotting**

**Jatrofa planting**

**SMART City**

# We have Thousands of Innovative & unique Businesses

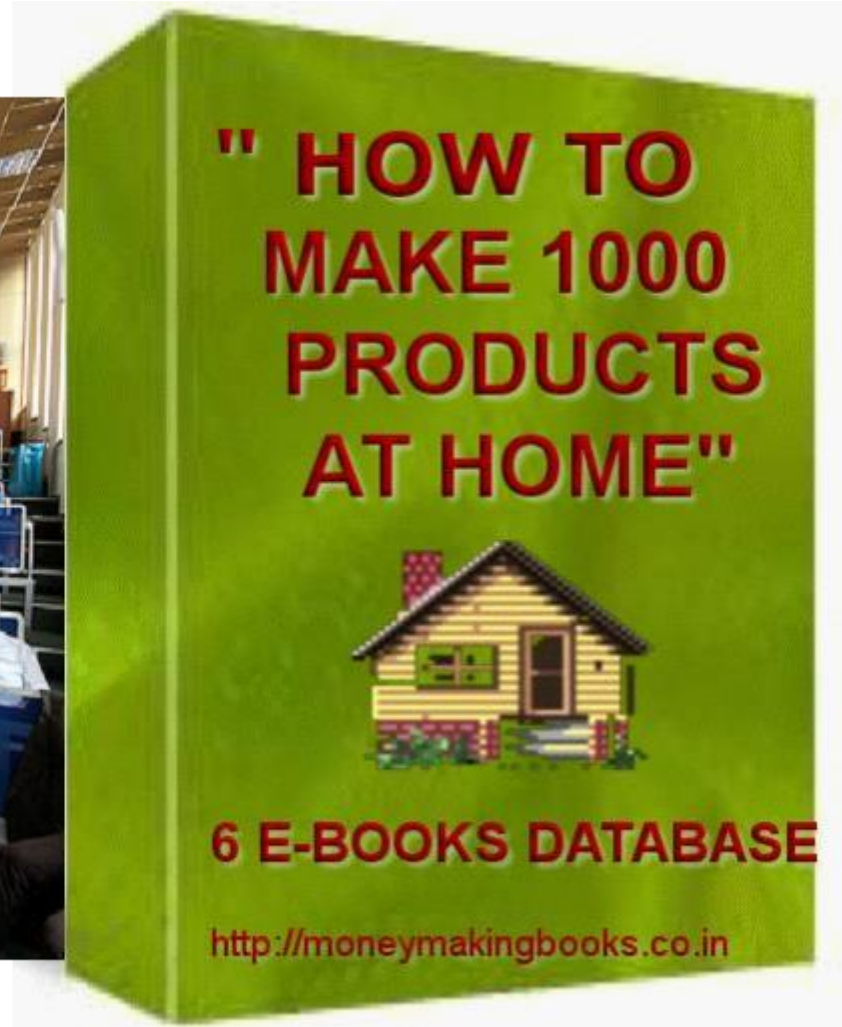

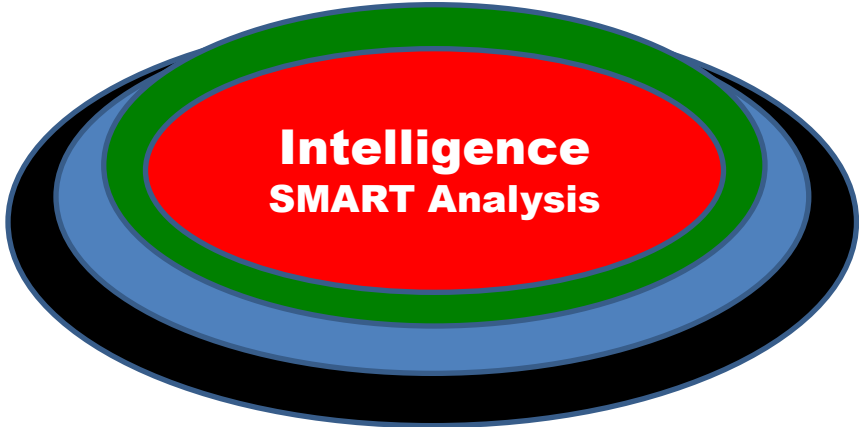

**Vision  
Invention**

**Success  
&  
Happiness**

**Money**

**Plan**

**Management**



# United East Asia



**If we know the life.....**





Welcome



SUCCESS



# Decide !



## ORDINARY LIFE

DISEASE, ANXIETY, FEAR, POVERTY

रोग, चिंता, भय, गरीबी

## HAPPY LIFE

HEALTHY, HAPPY, RESPECTFUL, PROSPEROUS, TRAVEL, VISA

स्वस्थ, सुखी , इज्जतदार , समृद्धि , यात्रा



# PRACTICAL WORKSHOP

## Sub-Conscious Mind Programing

spiritual seeds



Earth



Venus



Mars



Mercury



Pluto



Jupiter

Saturn

Uranus

Neptune

Earth →

← Pluto

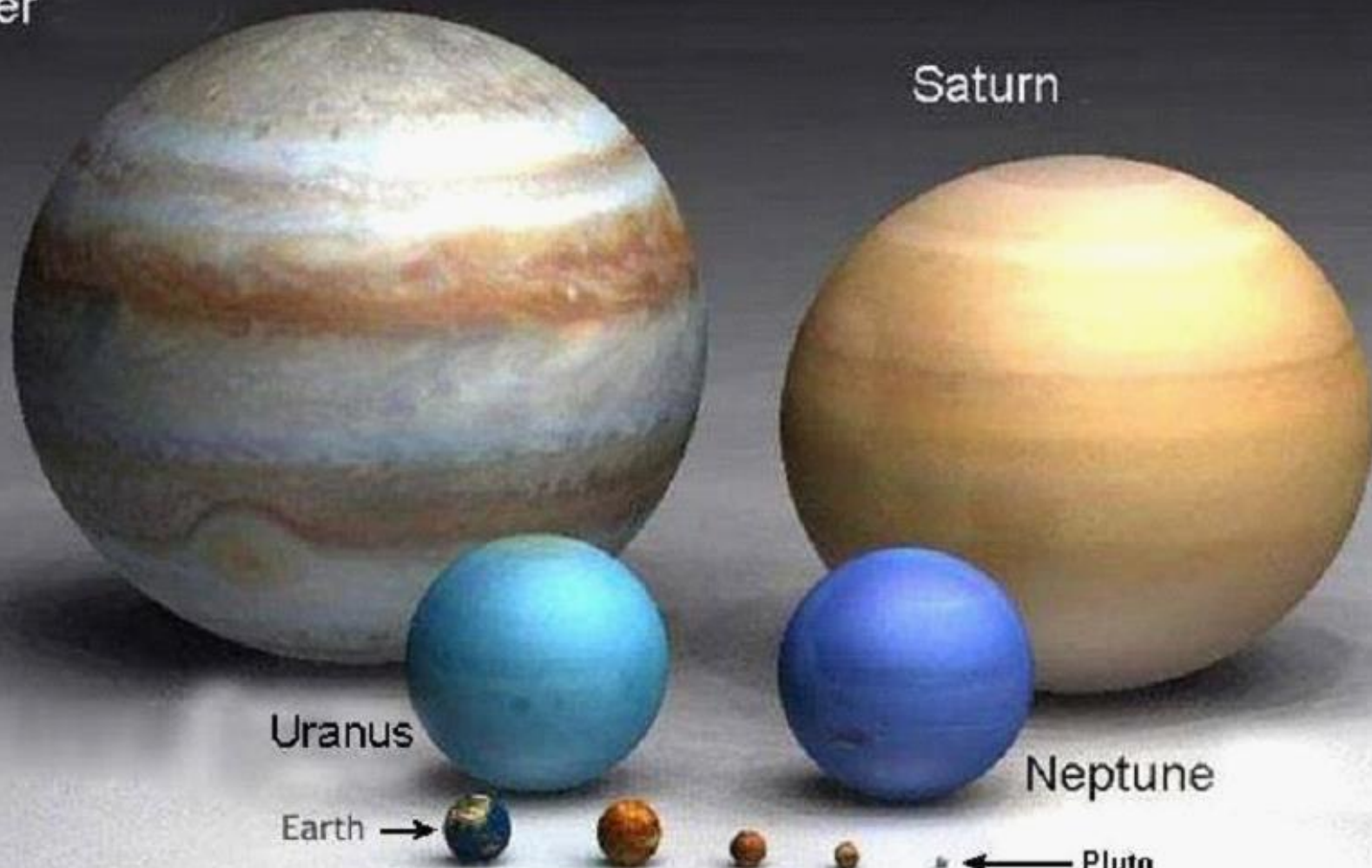

Sun



Jupiter



Earth

Pluto



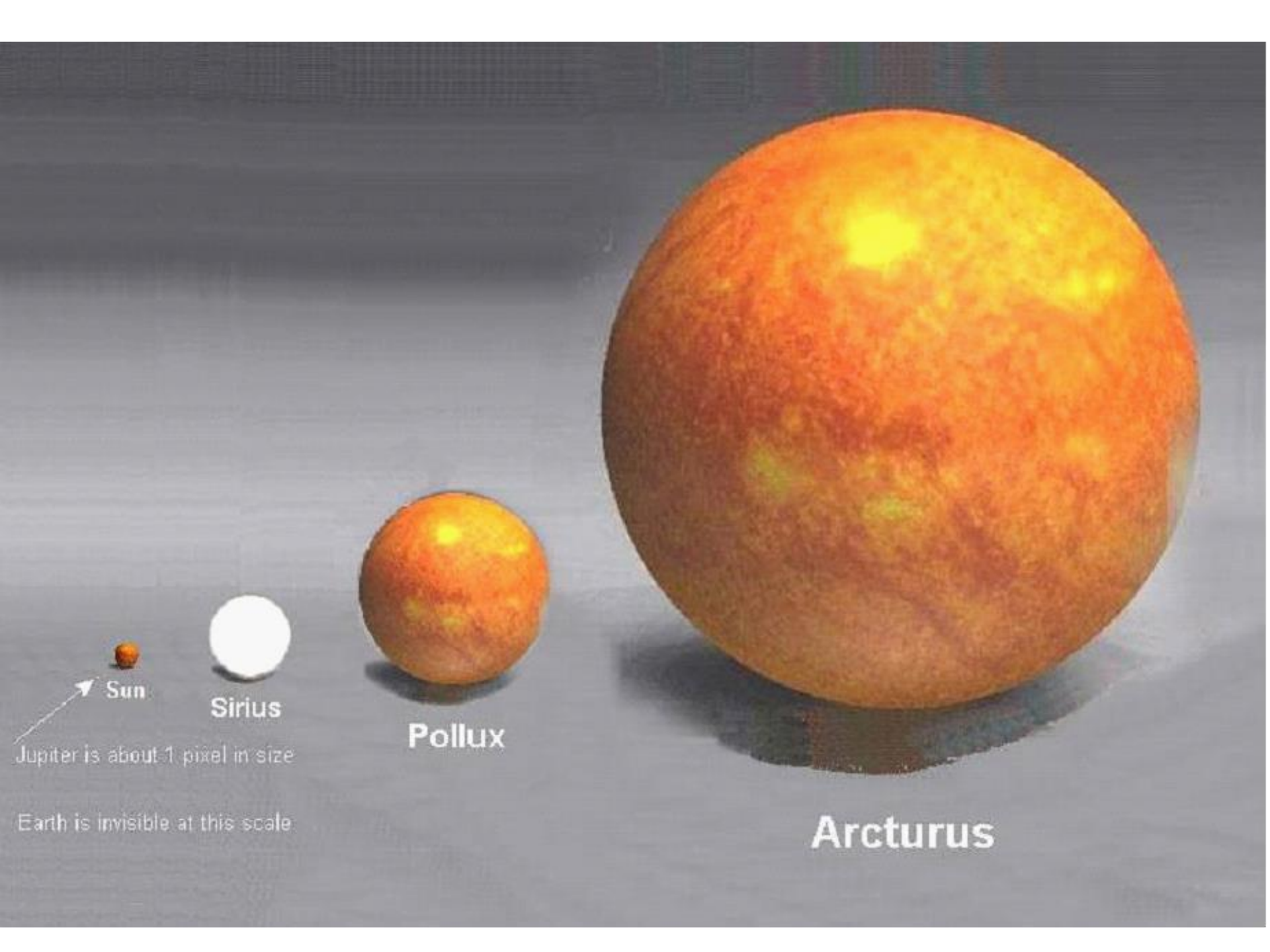

Sun

Sirius

Pollux

Arcturus

Jupiter is about 1 pixel in size

Earth is invisible at this scale



Betelgeuse



Antares



Rigel



Aldebaran



Sun (1 pixel)

Jupiter is invisible at this scale

Sirius Pollux

Arcturus





अमेरिका

चाईना

भारत

नेपाल

शिव



# Supernatural power



अलौकिक शक्ति



# Sub Conscious Mind Programing

Pineal Gland Activation  
**3<sup>rd</sup> Eye Open**

**Vibrations & Aura**

**Secret of Success**

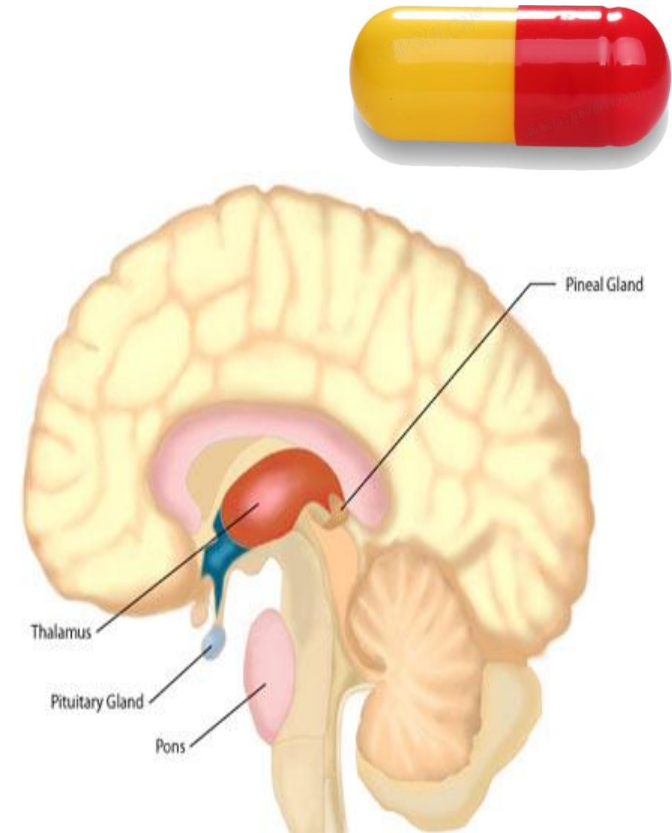

**Secret of Success**  
For  
**Personal or Global**

**Innovative**  
**The Theory of Glorious Revolution**

**Health**

**Intelligence**

**Money**

**Happiness**



Can be travel in Any Country

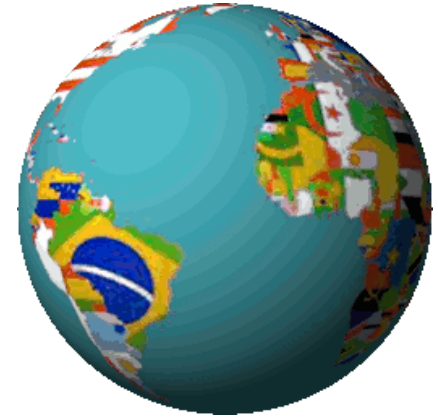

**A SMART Country**  
**Smart Village**

*Link with GOD*

*Link with H i*

*Link with iii*

# BLOCKAGE & Solutions ?

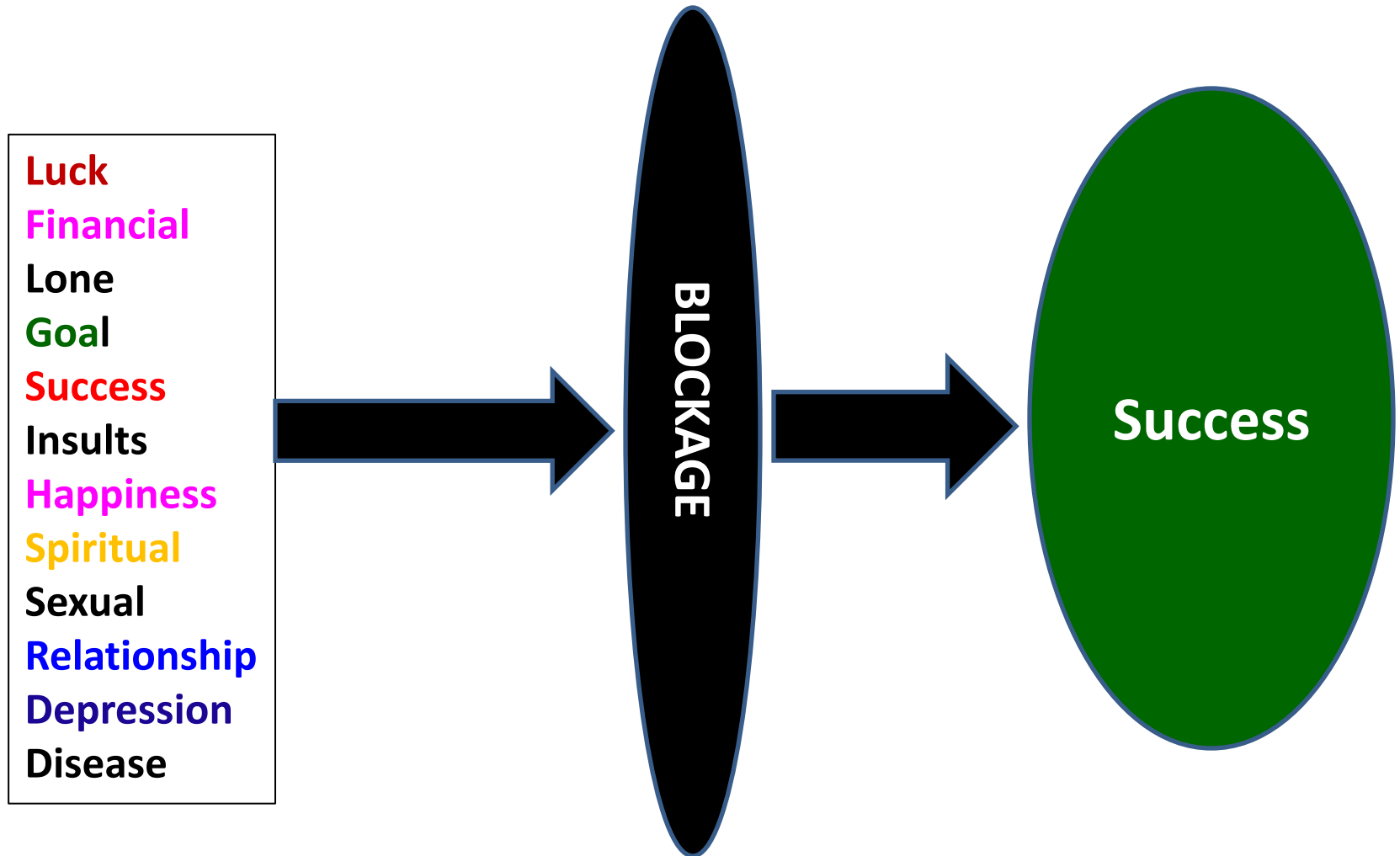





# Unlimited Human Potential

Intelligence

Work

Money

Happiness



# Practical Workshop

**Healing Power**

**Subconscious Mind Programming**

**Defragment**

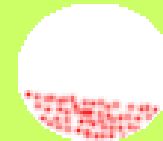

**Unlock the Mind Power (NLP)**

**Midbrain Activation**

# One day before

- Vegetarians food
- No Alcohols
- Loose Dress
- No Speak
- No metallic/jewel
- Sleep Alone for one day
- No Mobile phone

# Awarded

- **To Travel all around the World ( USA, CANADA, Australia, Japan, Singapore, Hong Kong, London....**
- **To Explore the Peace in all over the World.**
- **Explore the secret of Success & wealth.**
- **To explore the secret of good Health.**
- **Change own Nation into a Smart Country.**
- **Greatest & Glorious Social movement of the World.**
- **TOT (Training of Trainers) Be a Certified Teacher.**



Your  
Knowledge  
Is  
Power

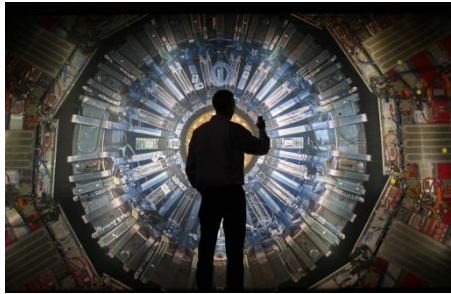

11Dimensions

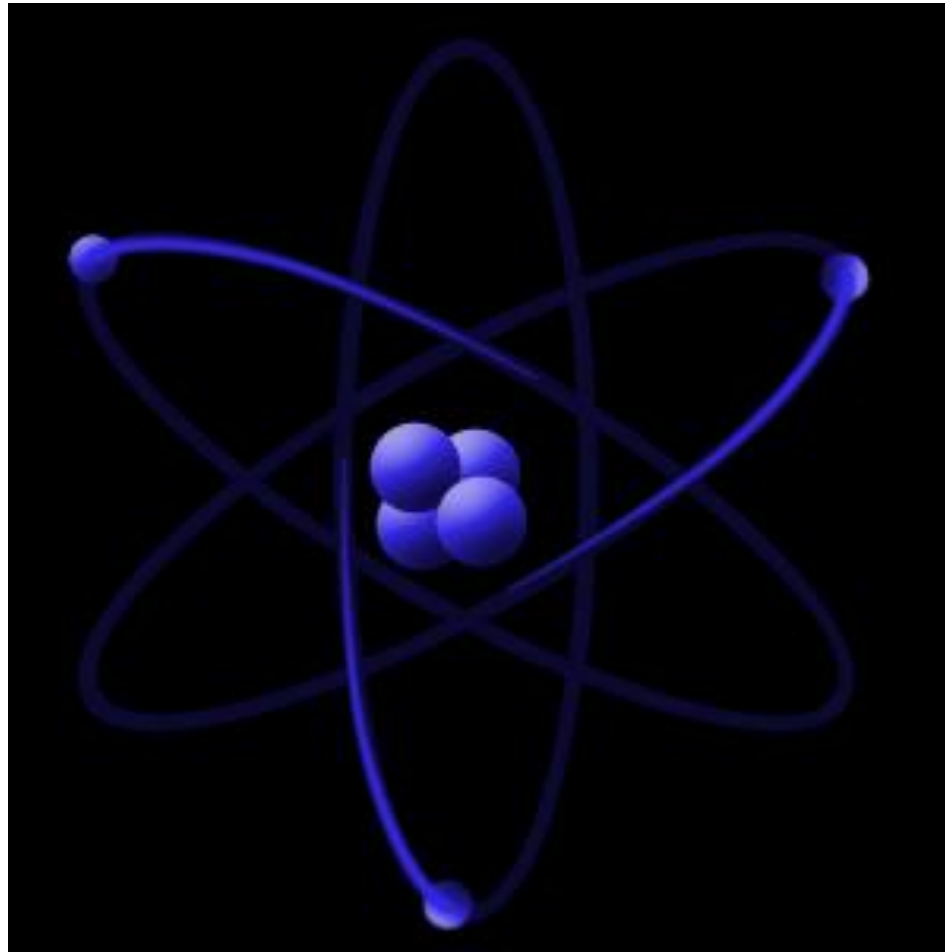

# Psychedelics & Meditation

Lysergic Acid diethylamide **LSD** Hallucinogenic D

# Queries



**Er. Kapil Paudyal**

**Patent Honor Scientist**

**The Great Innovation of 20<sup>th</sup> Century.**

**Third Glorious Revolution of the world**

Nepal Copyright Register's Office **"Hidden Intelligence"**

Copy Right No: 664

Hidden Intelligence Group Reg. No: 16591/069/70 (PAN)

Number : 600825540

ISBN No: 978-9937-2-2869-5 [www.iieyes.com](http://www.iieyes.com)

**YOCTO INFINITISM** (HMG Reg. No: 606575216)

Nepal

**Call: 9823822458**

**President**

**International Institute of Infinitism**

**USA/Canada/India**

[www.iieyes.com](http://www.iieyes.com)

**Call USA: +1 3372493028**



# References

[http://www.google.com.np/imgres?q=small+hydro+nepal&hl=en&gbv=2&tbn=isch&tbnid=5vTjNcNI\\_Qc6jM:&imgrefurl=http://geoportal.icimod.org/NAE/NewsDetail.aspx%253FNewsID%253D177&docid=1JaOY\\_k3Xnb8tM&w=450&h=300&ei=dVpHTqLYGIGvrAfjrPjsAw&zoom=1&iact=hc&vpx=512&vpy=259&dur=909&hovh=183&hovw=275&tx=139&ty=102&page=13&tbnh=133&tbnw=175&start=146&ndsp=12&ved=1t:429,r:10,s:146&biw=994&bih=625](http://www.google.com.np/imgres?q=small+hydro+nepal&hl=en&gbv=2&tbn=isch&tbnid=5vTjNcNI_Qc6jM:&imgrefurl=http://geoportal.icimod.org/NAE/NewsDetail.aspx%253FNewsID%253D177&docid=1JaOY_k3Xnb8tM&w=450&h=300&ei=dVpHTqLYGIGvrAfjrPjsAw&zoom=1&iact=hc&vpx=512&vpy=259&dur=909&hovh=183&hovw=275&tx=139&ty=102&page=13&tbnh=133&tbnw=175&start=146&ndsp=12&ved=1t:429,r:10,s:146&biw=994&bih=625)

[http://en.wikipedia.org/wiki/Power\\_line\\_carrier\\_communication](http://en.wikipedia.org/wiki/Power_line_carrier_communication)

[http://www.google.com.np/imgres?q=PLC+Power+line+carrier+communication&hl=en&gbv=2&biw=1024&bih=667&tbn=isch&tbnid=p9W5vemCOvfMHM:&imgrefurl=http://www.archnetco.com/english/product/product\\_s1.htm&docid=gBLAubn\\_cOulvM&w=477&h=311&ei=s\\_5NTr7cGMOJrAeQv\\_2NCw&zoom=1&iact=hc&vpx=239&vpy=73&dur=32&hovh=181&hovw=278&tx=148&ty=83&page=1&tbnh=103&tbnw=158&start=0&ndsp=20&ved=1t:429,r:1,s:0](http://www.google.com.np/imgres?q=PLC+Power+line+carrier+communication&hl=en&gbv=2&biw=1024&bih=667&tbn=isch&tbnid=p9W5vemCOvfMHM:&imgrefurl=http://www.archnetco.com/english/product/product_s1.htm&docid=gBLAubn_cOulvM&w=477&h=311&ei=s_5NTr7cGMOJrAeQv_2NCw&zoom=1&iact=hc&vpx=239&vpy=73&dur=32&hovh=181&hovw=278&tx=148&ty=83&page=1&tbnh=103&tbnw=158&start=0&ndsp=20&ved=1t:429,r:1,s:0)

<http://mysticnumbers.wordpress.com/category/month-energies/>

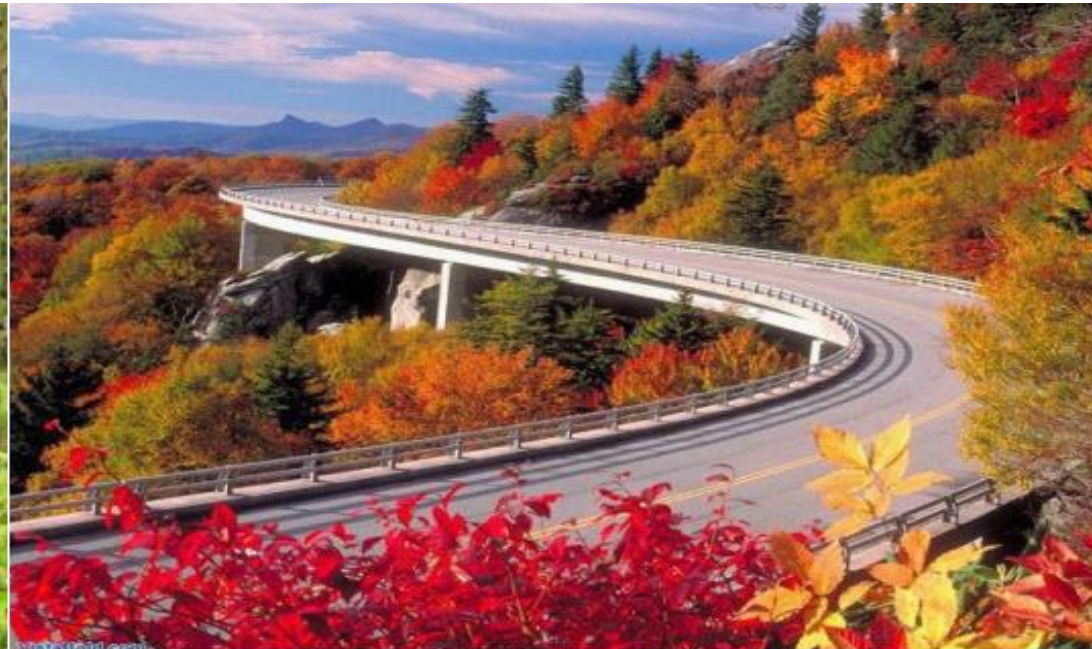



म संसार कै धनि  
देशको एक गरिब बालक!

नमस्कार

Thank you!

